

EMCO



CNC turning center for bar stock work up to \varnothing 45 (51) mm and chucking work



EMCOTURN E45

EMCOTURN E45 IN THE TAILSTOCK VERSION

Perfect European engineering, superbly equipped with a Y axis, 200 mm more machining length, C axis, driven tools with a 4 kW drive performance and a choice of a Siemens, Fanuc or Heidenhain control unit. A cost-effective bar loader package or an integrated automation solution is available on request.



Threaded bolt
(Heat treatable steel)

1 WORK AREA

- / Plenty of open space
- / Straight chip fall
- / Top ergonomics

2 TOOL TURRET

- / 12 stations VDI 30 axial
- / 6 stations driven
- / Tapping without length compensation
- / Polygonal turning, engraving, etc.

3 SPINDLE

- / High drive performance
- / Thermoresistant construction
- / Large speed range
- / A2-5 spindle connection
- / Bar capacity \varnothing 45 (51) mm

4 CONTROL UNIT

- / State-of-the-art control technology
- / FANUC OiTF / 15" incl. Manual Guide i
- / SINUMERIK 828D / 15" incl. Shop Turn
- / HEIDENHAIN CNC PILOT 640 / 15.6" incl. Smart Turn





5 SHELF

- / Space for measuring devices and operating tools
- / Optional for the Sinumerik PC keyboard

6 Y-AXIS

- / Travel +40 / -30 mm
- / 90° implemented in the machine construction
- / Large distance between guide rails
- / Stable and compact construction, without restrictions

7 MACHINE HOUSING

- / Comprehensive protection against chip flying
- / 100% coolant-leakproof
- / Large door safety glass
- / Free view into the workroom
- / Built-in buttons make it easier to operate the machine
- / Easy to clean the coolant tank

EMCOTURN E45 IN THE COUNTER SPINDLE VERSION

The EMCOTURN E45 SMY. The perfect solution for economic, off-the-shelf complete machining. Fitted with a counter spindle, driven tools, a high-precision C axis and extrem fast rapid motion speeds, the EMCOTURN E45 SMY gives you everything you need for manufacturing complex turned-milled parts efficiently and at a low price. The highlight of the machine is its very stiff Y axis with long travel – for almost unlimited machining capabilities with maximum precision.



Eccentric disc
(Aluminium)

1 WORK AREA

- / Plenty of open space
- / Straight chip fall
- / Top ergonomics

2 TOOL TURRET

- / 12 stations VDI 25 radial
- / 12 stations driven
- / Servo controlled with adjustable swivel speed
- / Tapping without length compensation
- / Polygonal turning, engraving, etc.

3 SPINDLE

- / High drive performance
- / Thermoresistant construction
- / Large speed range
- / A2-5 spindle connection
- / Bar capacity \varnothing 45 (51) mm

4 COUNTER SPINDLE

- / Complete machining of components
- / Incl. C-axis for milling operations
- / Incl. part ejector
- / Incl. flushing
- / Optionally available with a passage for unloading long shaft parts

5 EMCO SHORT BAR LOADER SL1200

- / Bar diameter 8 – 95 mm
- / Bar length 250 – 1200 mm
- / Material support 560 x 1210 mm
- / Dimensions 1700 x 1250 mm
- / 400 mm displaceable





6 CONTROL UNIT

- / State-of-the-art control technology
- / FANUC 0iTF / 15" incl. Manual Guide i
- / SINUMERIK 828D / 10,4" incl. Shop Turn
- / HEIDENHAIN CNC PILOT 640 / 15,6" incl. Smart Turn

7 SHELF

- / Space for measuring devices and operating tools
- / Optional for the Sinumerik PC keyboard

8 Y-AXIS

- / Travel +40 / -30 mm
- / 90° implemented in the machine construction
- / Large distance between guide rails
- / Stable and compact construction, without restrictions

9 MACHINE HOUSING

- / Comprehensive protection against chip flying
- / 100% coolant-leakproof
- / Large door safety glass
- / Free view into the workroom
- / Built-in buttons make it easier to operate the machine
- / Easy to clean the coolant tank

10 FINISHED PARTS CONVEYOR

- / Large storage capacity
- Æ Automatic indexing
- Æ Incl. chip drawer

DESIGN

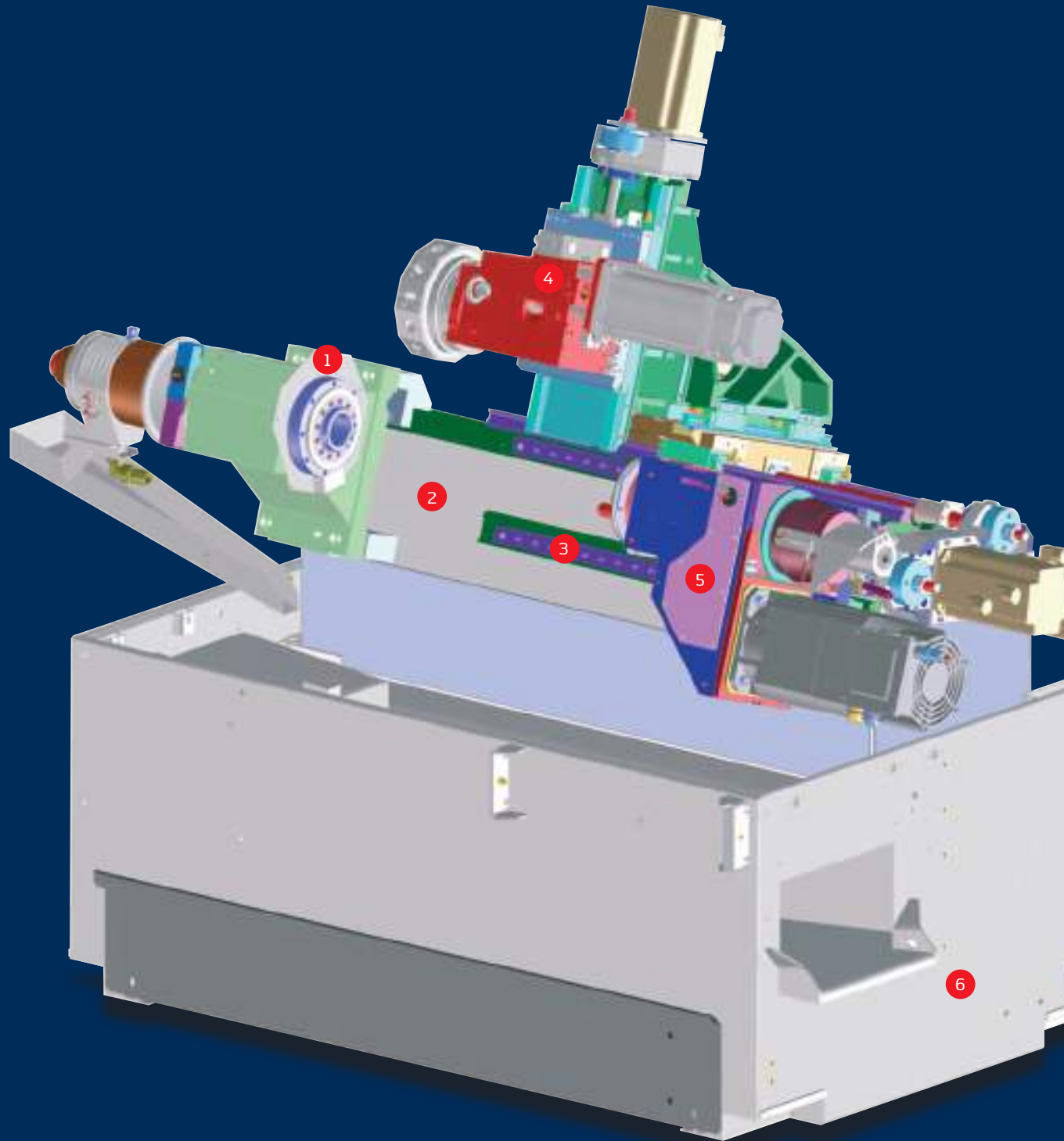

1 MAIN SPINDLE

- / High drive power
- / Compact, thermostable construction
- / Large speed range
- / A2-5 spindle nose
- / Bar capacity diameter 45 mm (51)

2 MACHINE BED

- / Extremely stiff welded steel fabrication
- / Compact structure
- / Very high thermostability
- / Filled with vibration-absorbing material

3 ROLLER GUIDES

- / In all linear axes
- / Preloaded
- / No backlash in any direction of force
- / High rapid motion speeds
- / No wear
- / Minimal lubrication

4 TOOL TURRET

- / VDI quick change system
- / 12 driven tool stations
- / No alignment of the tool holder
- / Can be used on both spindles
- / Swivel speed adjustable with override

5 COUNTER SPINDLE

- / Large speed range
- / C-axis
- / Spindle clamp
- / A2-4 spindle nose

6 MACHINE STAND

- / Thermally isolated from the machine base
- / Coolant container that is larger and easier to clean
- / No levelling necessary
- / 100% sealed against coolant leaks

VALIDATED QUALITY

/ ROUNDNESS AND SURFACE QUALITY

Material:	Brass (Cu Zn 40 Pb 2)
Cutting tool:	Wendeplatte CCGX 09 T3 04-AL
Turning diameter:	ø 55 mm
Cutting speed:	300 m/min
Feed rate:	0,025 mm/rev
Cutting depth:	0,03 mm

/ AS MEASURED ...*

Roundness:	0,45 µm
Surface finish:	Ra = 0,163 µm

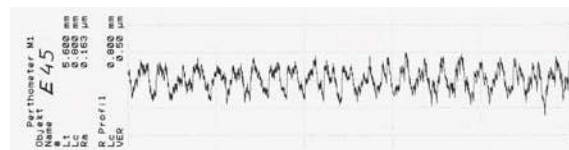

/ REPEAT ACCURACY

Material:	Steel - 16 Mn Cr 5
Turning diameter:	ø 45 h6
Tolerance:	16 µm
Spindle speed:	2000 rpm
Feed rate:	0.08 mm/rev
Cutting depth:	0.2 mm

LONG TERM MACHINING ACCURACY: 4 µm

/ AS MEASURED ...*

Range:	4 µm
Cm value:	2,57

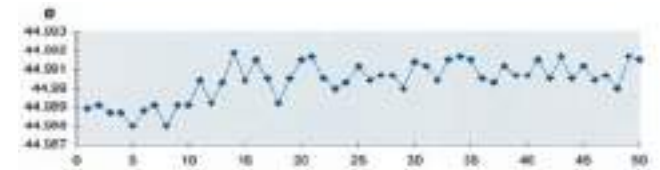

*...The actual results may be affected by a number of factors, such as Warm-up cycles, speeds, feeds, tools, coolant, material, ambient temperature, etc., should be higher or lower than those listed.

TECHNICAL HIGHLIGHTS



COUNTER SPINDLE AND PARTS CATCHER

The counter spindle includes a parts ejector with stroke monitoring and coolant feed. It ejects the parts automatically into the parts catcher, which then removes them from the machine and stores them in a bin or on an accumulating conveyor.



MAIN SPINDLE

The main spindle with four bearings provides the prerequisites for bar machining as well as chuck part machining. Collet chucks, 3-jaw chucks and mandrels can be mounted on the standardized spindle connection A2-5. For shaft applications, face drivers are also available for machining between centers.

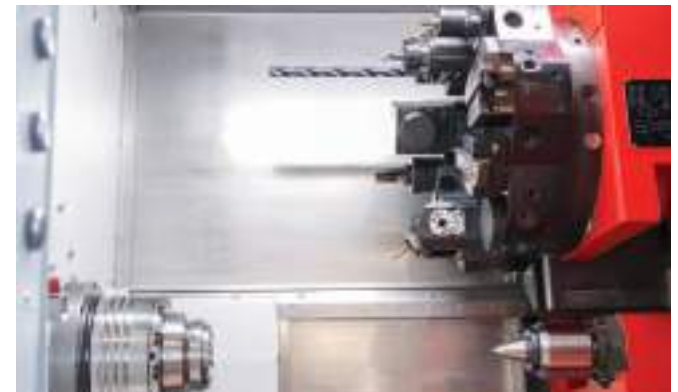

AXIAL TOOL TURRET

12-station axial style tool turret VDI30 with two bolt hole circles. The outer for the stationary tools, the inner one for up to 6 driven tool. No tool rise, interconnection with directional logic. Switches with bidirectional logic DIN 5480 coupling.



COUNTERSPINDLE

The counter spindle is available for complete machining of the workpieces. This allows turning, milling and drilling operations to be carried out on the back of the workpieces. The concentric transfer of the workpieces also has the advantage that very high accuracies with regard to coaxiality, concentricity and angular position can be maintained.



TAILSTOCK

On the EMCOTURN E45 with tailstock, the tailstock is set up on the linear roller slide and can be automatically positioned within a range of 510 mm. The live center is integrated into the body of the tailstock and can be removed using a pressure wedge.

HIGHLIGHTS

- / Powerful driven tools
- / Y-axis for complex milling operations
- / Counter spindle for complete machining
- / Flexible automatic tailstock
- / Excellent machining precision
- / Very compact machine layout
- / State-of-the-art control technology from Siemens, Fanuc or Heidenhain incl. Shop Turn / Manual Guide i / Smart Turn
- / Made in the Heart of Europe



RADIAL TOOL TURRET

12-position VDI 25 radial turret with single-motor engineering. A servo motor powers the driven tools and the swivel movement. No tool rise. Switches with bidirectional logic. Every station can hold driven tool holders with a DIN 5480 coupling.



CLAMPING STROKE MONITORING ON THE MAIN AND COUNTER SPINDLES

The clamping positions of the two clamping cylinders can be easily taught-in by means of the programmable clamping stroke monitoring. This eliminates the need for handling the cylinders. This leads to short set-up times.

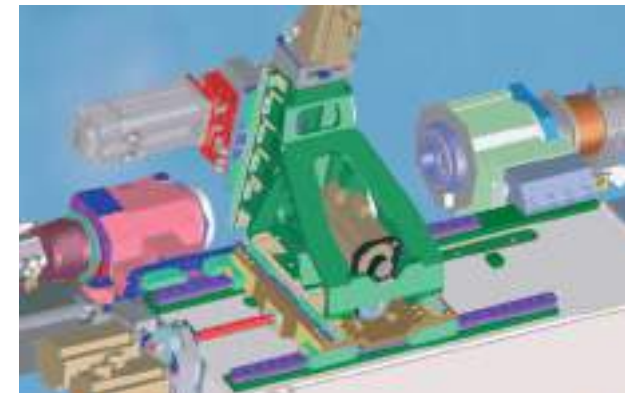

Y-AXIS

The Y-axis is integrated into the basic machine structure and stands at 90° to the X-axis. Extremely short projections form the basis for solid turning and drilling operations, as well as milling operations without interference contours.

THE CNC CONTROL UNIT: THE BRAINS OF EACH CNC LATHE

Machine tools are facing ever-increasing requirements. They are supposed to be ever faster, ever more precise and ever more user-friendly! Nowadays, these criteria are met by modern CNC control units. What is new, however, is the wish for networking, something that the state-of-the-art controls included in EMCO's machine tool program are capable of. Many customers are asking for standardized control units within their production. In order to cater for these needs, the EMCOTURN E45 is available with three control versions.

SINUMERIK 828D

High-performance CNC control for maximum precision and processing speed. Thanks to a flexible CNC programming language and unique ShopTurn work stage programming, both large-scale production parts and individual workpieces may be programmed and machined with maximum efficiency.

With powerful kinematic transformations and a comprehensive set of technology cycles, the SINUMERIK 828D is also ideal for sophisticated machining with driven tools and counter spindle.



3D-simulation

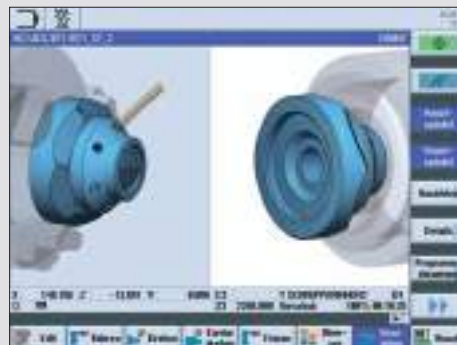

EMCO diagnostic images

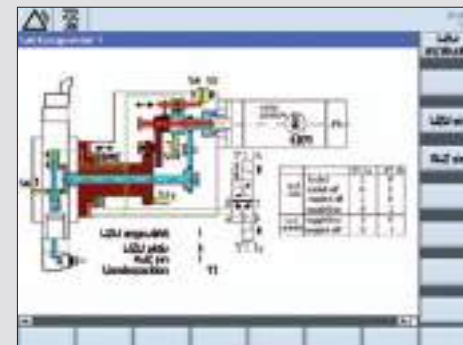

FANUC OiTF

The CNC-series OiTF model is the ideal solution for compact high-end lathes. An attractive price-performance ratio teamed with unmatched dynamics, precision and reliability. This control unit is characterised by easy operation and programmability. Using the FOCAS interface, it can easily be connected to higher-level IT systems, whilst offering maximum performance and functionality. Easy and rapid automation by means of a robot or gantry loader is guaranteed.



3D-simulation



EMCO diagnostic images

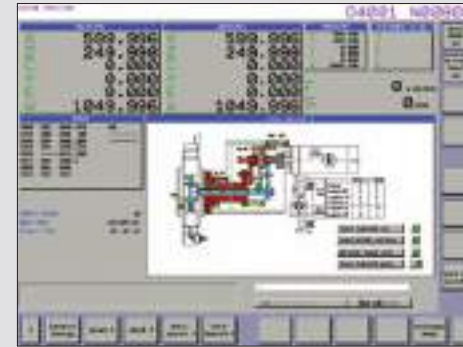

HEIDENHAIN CNC PILOT 640

Thanks to the flexible design and due to its versatile programming possibilities, Heidenhain's CNC PILOT 640 always offers the right support – regardless of whether you manufacture simple or complex workpieces. The CNC PILOT 640 is characterised by easy operation and programming, which is why it requires only little training.



3D-simulation

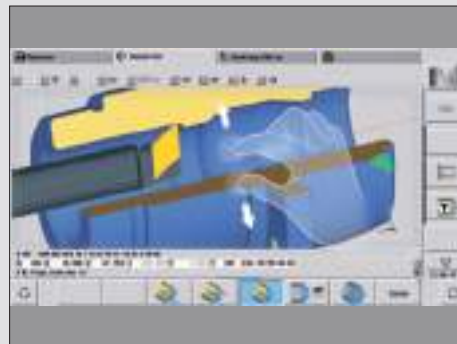

SmartTurn programming assistant



THE EMCO SWING LOADER. THE INTEGRATED SOLUTION.

Tailor-made solutions. For preformed blanks and parts with a diameter larger than the spindle capacity, we offer an integrated swing loader for fully automatic loading and part removal. This has been designed to form a harmonious single entity with the machine. The machine control system takes care of positioning. A short bar loader and a 3-meter bar loader are available from EMCO for workpieces made from bar stock.



ADVANTAGES

- / Fully automated loading and unloading of the workpieces
- / Short loading and unloading time
- / Flexible for shaft or flange parts
- / Oriented loading into the clamping device
- / Simple programming via the Sinumerik control
- / CNC-controlled servo movements

MAXIMUM OUTPUT – MINIMUM SPACE REQUIRED.

The EMCO swing loader is a universal loading system for all types of preformed blanks. It can be customized individually to the customer's requirements using numerous gripper and handling systems. How we do it: we standardize the components but create a customized solution. The result: a custom-tailored machine for the same price as a standard unit.

Blank feeding systems, gripper and handling systems

Feed systems specific to particular blanks allow preformed workpieces to be loaded in the working spindle correctly oriented, which enables economical unmanned operation.



Large storage capacity chain feeding system for loading preformed blanks with the correct orientation.



Multiple infeed chutes for loading rotationally-symmetrical blanks. The length of the blanks determines the number of infeed chutes.



Chain feeding system with V-supports for preformed shaft parts of various shapes.



Multiple infeed chutes for loading rotationally symmetrical blanks. A sensor monitors the availability of blank parts for each infeed chute.



Shaft gripper for automatically loading pre-formed shafts.



Fully automatic shaft loading. Feed-in via a conveyor belt, removal via the finished parts pick-up device.

A wide range of gripper and handling systems.



2-finger gripper with 180° rotary module for loading blanks fed in vertically

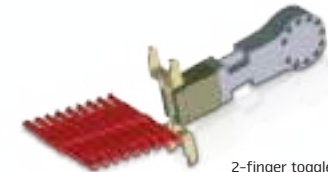

2-finger toggle lever gripper for loading shaft parts

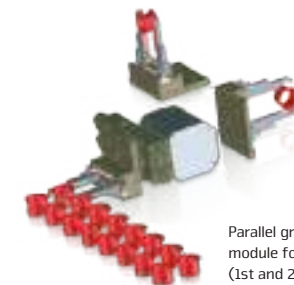

Parallel grippers with 180° rotary module for loading shaft parts (1st and 2nd chucking)

/ OPTIONS

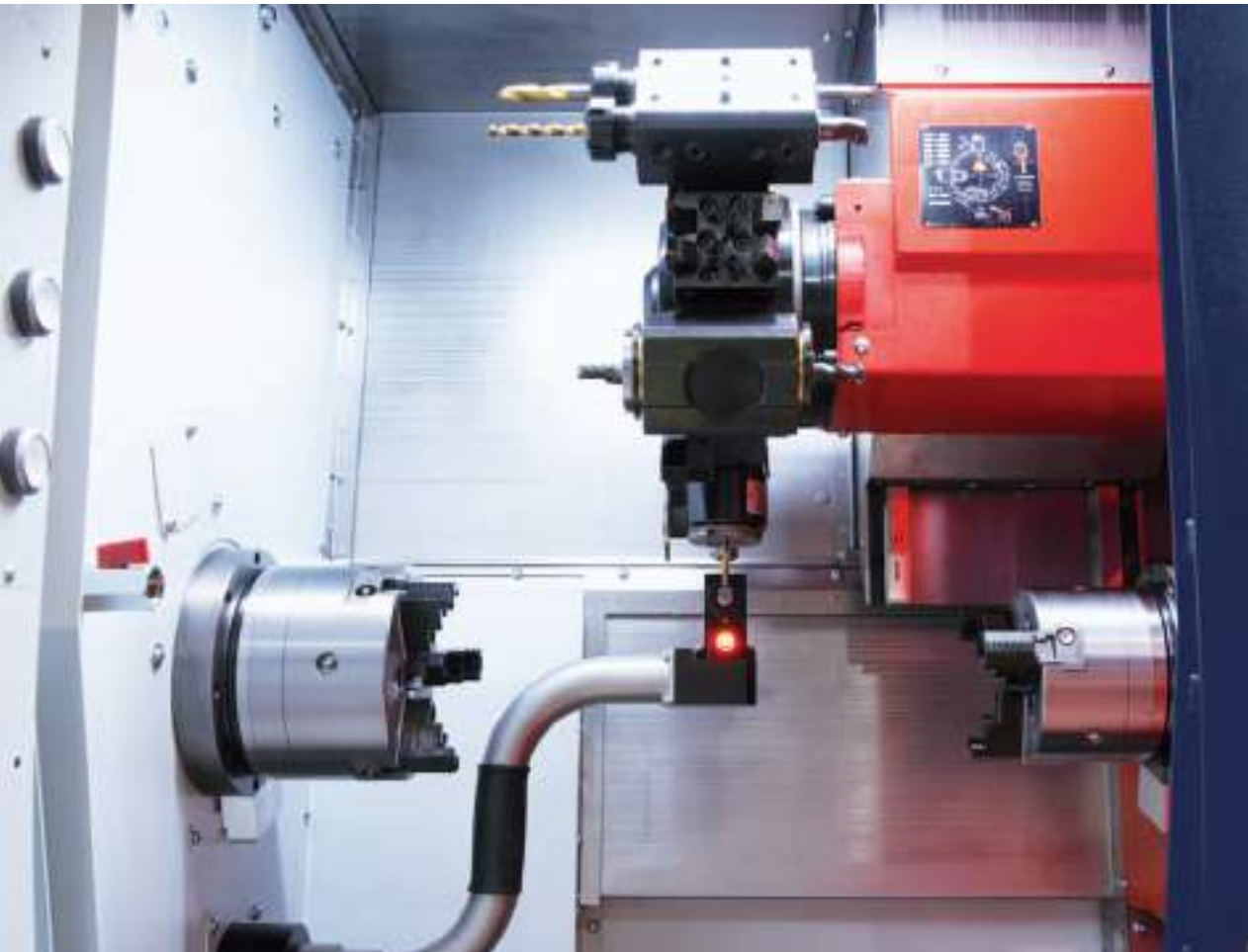

TOOL MEASUREMENT

The optional tool measuring sensor in the work area allows for fast and precise tool measurement within the machine. It is manually mounted below the main spindle. After use, it is removed and placed onto a tray on the left-hand side of the machine casing.



MEASURING ARM STORAGE

Protected storage area for the measuring ARM and the adjustment gauge.



BAND-PASS FILTER UNIT

If required, it is possible to install an optional 600-litre band-pass filter unit with 25 bar high-pressure coolant pumps. It increases both the cooling emulsion volume and the coolant's service life.



HOLDING BRAKE ON MAIN AND COUNTER SPINDLE

For milling and drilling operations, the respective C axis is always positioned. However, each spindle can also be clamped in any position.



SPINDLE EXTENSION FOR SHORT BAR LOADER

The spindle extension can be offered for processing cut-to-length material bars up to a length of 1200 mm. The cut-to-length bar material can then be fed fully automatically with the SL1200.



FINISHED PARTS CONVEYOR

The finished parts catcher places the machined parts onto a collector belt. Since the belt is clocked, the parts – which are often very complex – are kept from falling on top of each other.



EMCO SHORT LOADER

In order to tackle the ever-increasing pressure relating to machine footprints, EMCO has developed the most compact short loader available on the market: EMCO SL 1200.



MATERIAL SUPPORT

The material support attached to the back of the SL 1200 features a surface of 560 x 1210 mm and allows stocking a large number of bars. This allows for unmanned production. To ensure compliance with the safety guidelines, the material support is covered by a hood.



OPERATING PANEL

The operating buttons and the diameter adjustment are located on the front side of the SL 1200. If required, the loader can easily be moved 400 mm to the left.

MACHINE LAYOUT

Machine layout E45
with EMCO SL1200

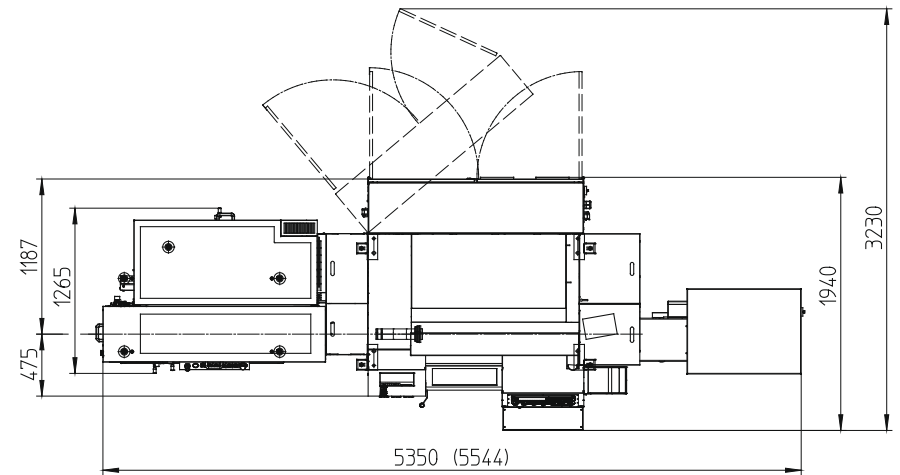
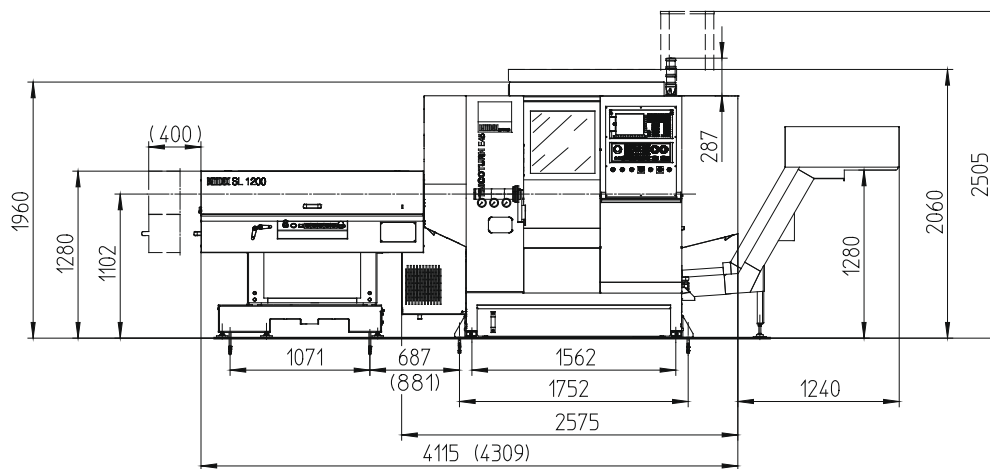

Indications in millimetres

WORK AREA

Work area E45
with counter spindle

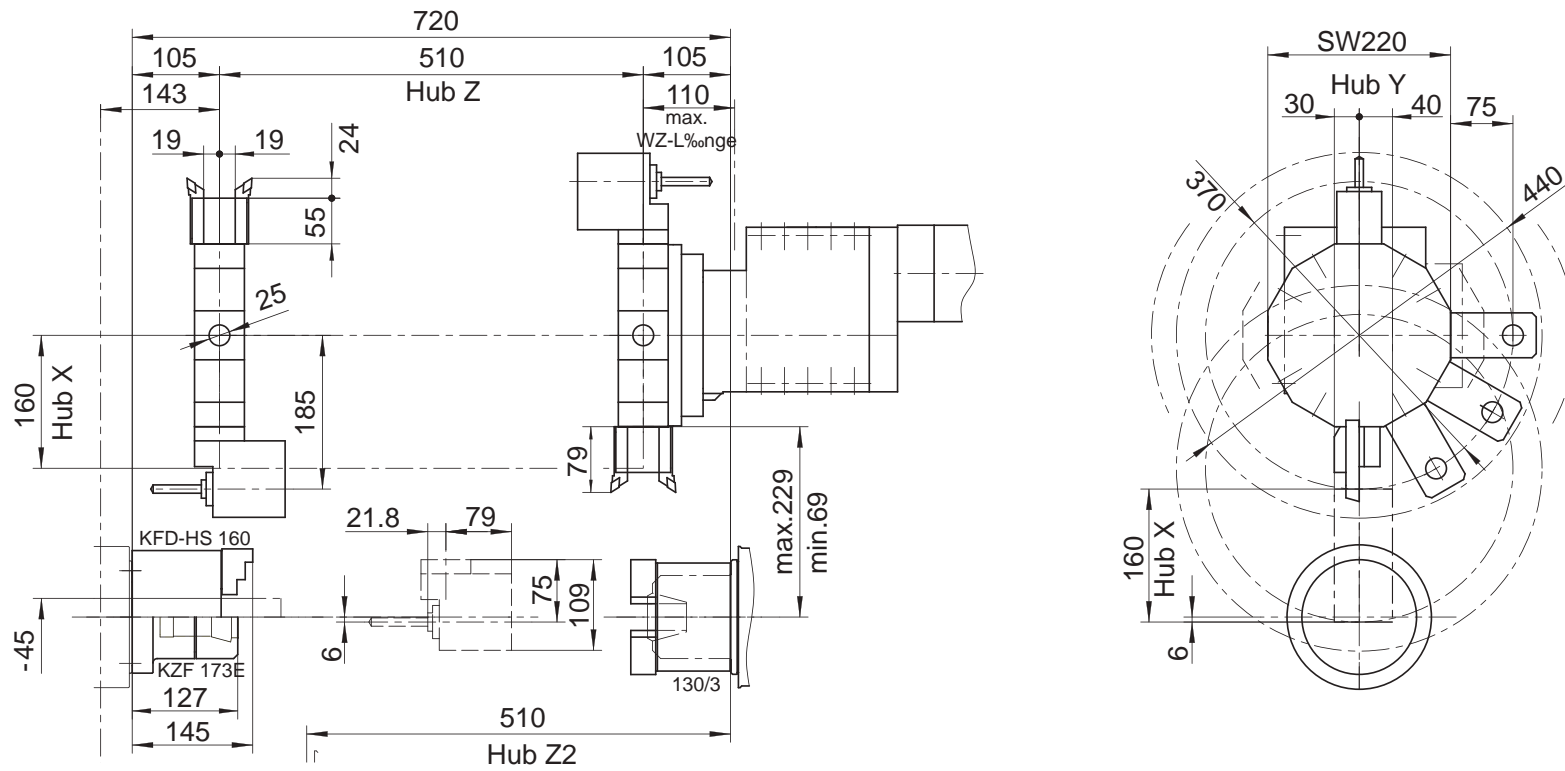

POWER AND TORQUE

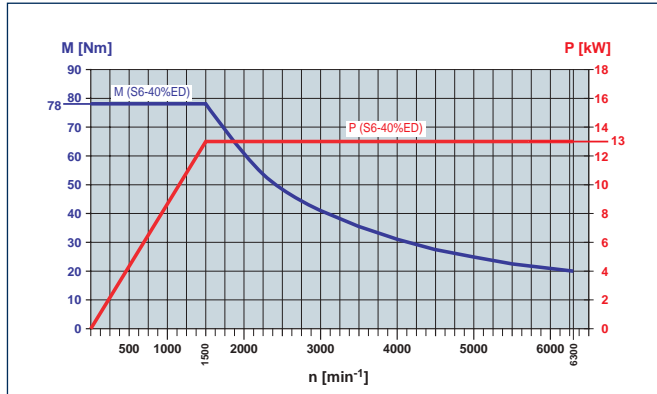

Motor characteristics for main spindle

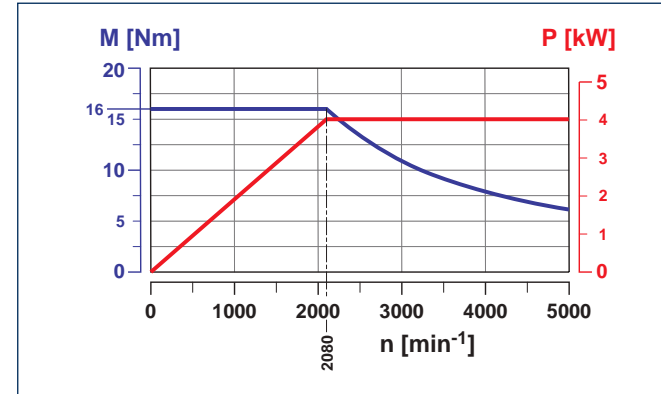

Motor characteristics for axial tool turret VDI30

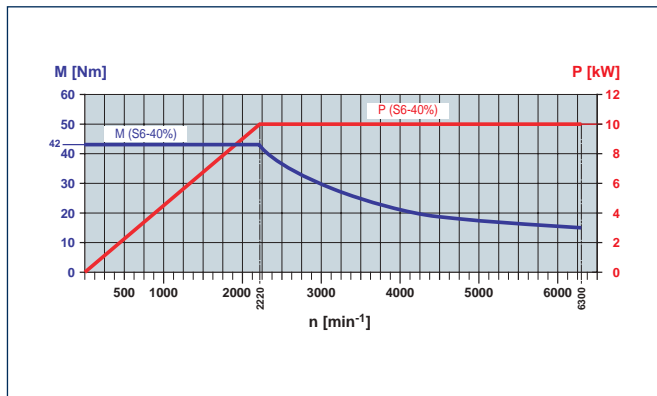

Motor characteristics for counter spindle

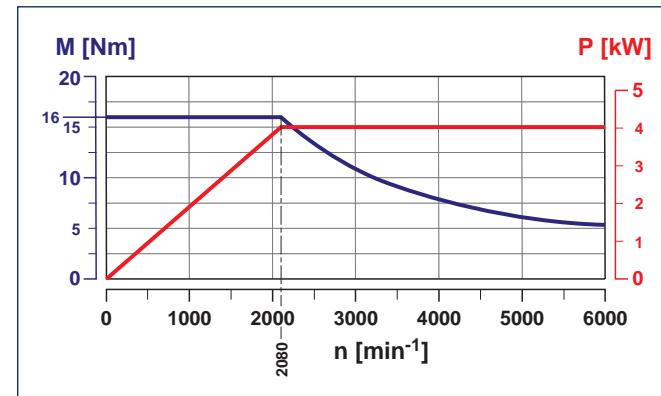

Motor characteristics for radial tool turret VDI25

TECHNICAL DATA

Work area

Swing over bed	430 mm
Swing over cross slide	300 mm
Distance between centers	670 mm
Distance between spindle noses f. counter spindle version	720 mm
Max. turning diameter with axial turret with radial turret	220 mm 300 mm
Maximum part length	480 mm
Maximum bar-stock diameter	Ø 45 (51) mm

Travel

Travel in X / Z	160 / 510 mm
Travel in Y	+40 / -30 mm

Spindle

Speed range	0 – 6300 (5000) rpm
Spindle torque	78 (100) Nm
Spindle nose DIN 55026	A2-5
Spindle bearing (inner diameter at front)	80 mm
Spindle bore	53 mm

Counter spindle

Speed range	0 – 6300 rpm
Spindle torque (Siemens / Fanuc)	42 / 43 Nm
Spindle nose DIN 55026	A2-4
Spindle bearing (inner diameter at front)	70 mm

C-axis

Resolution	0,001°
Rapid motion speed	1000 rpm
Spindle indexing	0,01°

Automatic tailstock

Travel	510 mm
Quill thrust	6000 N
Maximum travel speed	Approx. 20 m/min
Quill bore taper	MT 4

Drive Power

Main spindle	13 kW
Counter spindle (Siemens + Heidenhain / Fanuc)	10 / 7,5 kW

Tool turret axial / radial

Number of tool positions	12 / 12 mm
Tool holding shaft in accordance with (DIN 69880)	30 / 25 mm
Tool cross-section for square tools	20 x 20 / 16 x 16 mm
Shank diameter for boring bars	Ø 32 / Ø 25 mm
Turret indexing time	0,14 sec

Driven tools DIN 5480 axial / radial

Number of stations	6 / 12
Drive performance	4 / 4 kW
Maximum torque	16 / 16 Nm
Speed range	0 – 5000 / 0 – 6000 rpm

Feed drives

Rapid motion speed X / Y / Z	24 / 10 / 30 m/min
Feed force in the X / Y axes	4000 / 4000 N
Feed force in the Z-axes	6000 N
Acceleration from 0 to rapid speed X / Z	0,1 sec
Position variation Ps (according to VDI 3441) X / Y / Z	2 / 2 / 2 µm*

*...for machines including laser measurement and pitch error compensation

Coolant system

Tank volume (optional)	250 (750) Liter
Pump performance (optional)	0,57 (2,2 / 3) kW
Pump power (optional)	3,5 (14 / 25) bar

Power consumption

Connected load value	25 kVA
Air pressure required	6 bar

Dimensions

Height of center above floor	1100 mm
Machine height	1960 mm
Required space for machine L x D	2575 x 1760 mm
Total weight of the machine Tailstock / Counter spindle	3300 / 4000 kg

EMCO SL1200

Bar length	250 – 1100 mm
Bar diameter	Ø 8 – 51 mm
Material support	approx. 560 mm
Length	1700 mm
Width	1250 mm
Height (Spindle center)	1090 – 1380 mm
Weight	approx. 500 kg

Safety devices CE compliant

beyond standard /

EMCO GmbH / Salzburger Str. 80 / 5400 Hallein-Taxach / Austria / T +43 6245891-0 / F +43 624586965 / info@emco.at

www.emco-world.com